



MATTHEY-PETIT SA

Grues mobiles – Camions+grues – Transports – Manutentions

Route de Sorge 11
1030 Bussigny
021 634 41 04
info@matthey-petit.ch
www.matthey-petit.ch

Grue mobile automotrice 60 t

- Hauteur sous crochet maxi.: 33,5 m
- Pas de transport de contrepoids supplémentaire
- Portée maxi.: 30 m
- Levage de charges sur pneus à 360°
- Capacité de levage maxi.: 60'000 kg
- Capacité de levage en bout de flèche: 11'700 kg





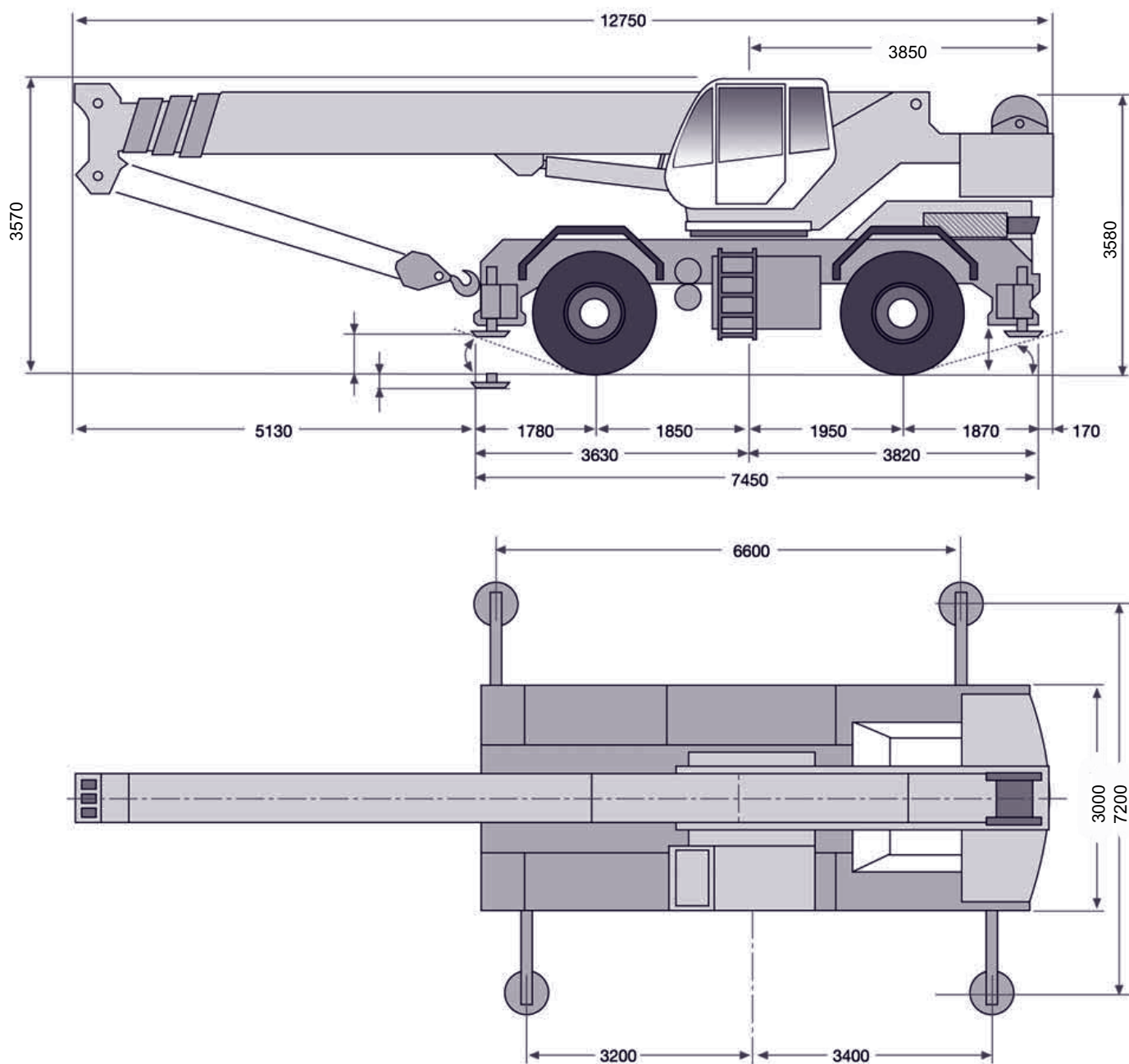

TEREX A600-1







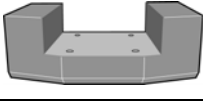
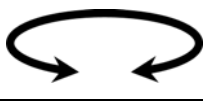







Dimensions et poids









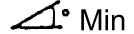

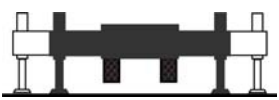

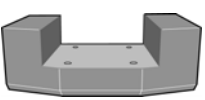













			
	40500 kg	18400 kg	22100 kg



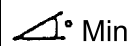

Note: values of standard machine without hook block · Remarque : valeur pour machine standard sans crochet moufle ·
 Hinweis: Angaben beziehen sich auf Serienmaschine ohne Unterflasche · Nota: valori della macchina base senza bozzello ·
 Nota: valores de máquina estándar sin gancho · Nota: valores da máquina padrão semmoltao ·
 Примечание. Значения даны для крана в стандартной комплектации без крюкоблока.







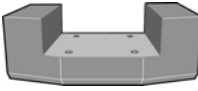









				
7.20 m	10.30m + 32.40m	8.70 t	360°	CODE 01

	t2 = 0%		t2 = 50%		t2 = 100%		t2 = 100%		t2 = 100%		t2 = 100%		t2 = 100%	
	t3 = 0%		t3 = 0%		t3 = 0%		t3 = 25%		t3 = 50%		t3 = 75%		t3 = 100%	
	t4 = 0%		t4 = 0%		t4 = 0%		t4 = 25%		t4 = 50%		t4 = 75%		t4 = 100%	
	10.30 m		14.00 m		17.70 m		21.30 m		25.00 m		28.70 m		32.40 m	
														
	Max 80°	60.00	Max 80°	41.00	Max 80°	33.80	Max 80°	24.70	Max 80°	19.90	Max 80°	15.50	Max 80°	11.70
3.0	67.50	60.00												
3.5	64.50	49.20												
4.0	61.00	45.00	70.00	41.00	75.00	33.80								
4.5	58.00	38.60	68.00	36.50	73.00	31.15								
5.0	55.00	36.00	65.00	36.00	71.50	28.50	75.00	24.70	77.50	19.90				
6.0	47.00	31.50	60.50	29.00	67.50	25.50	72.00	21.80	75.00	18.10	77.50	15.50		
7.0	36.50	25.00	55.50	24.00	64.00	21.50	68.50	19.00	72.00	16.40	75.50	14.40	78.00	11.70
8.0	23.00	19.80	50.00	19.50	60.00	18.60	65.50	16.90	69.50	14.70	73.00	13.10	76.00	11.00
9.0			44.00	17.00	56.00	16.80	62.50	14.70	67.00	13.40	71.00	12.30	74.00	10.60
10.0			37.00	14.00	52.00	13.80	59.50	13.50	64.50	12.10	69.00	11.20	72.00	9.60
11.0			27.00	13.00	47.50	11.30	56.00	11.30	61.50	9.80	67.00	10.30	70.00	8.80
12.0			13.00	10.90	42.50	9.70	52.50	9.70	59.00	9.00	64.50	9.50	68.00	8.20
13.0					37.00	8.40	49.00	8.40	56.00	8.40	62.00	8.80	66.00	7.60
14.0					30.00	6.80	45.00	7.20	53.00	7.20	59.50	7.10	64.00	7.10
15.0					22.00	6.60	41.00	6.40	50.00	6.40	57.00	6.40	62.00	6.40
16.0							36.00	5.80	47.00	5.80	54.50	5.80	60.00	5.80
17.0							31.00	5.10	43.50	5.10	51.50	5.50	57.50	5.60
18.0							25.00	4.50	40.00	4.50	49.00	4.40	55.00	4.30
19.0							15.00	4.00	36.00	4.00	46.00	4.10	53.00	4.00
20.0									31.50	3.60	43.00	3.40	50.50	3.70
21.0									26.00	3.15	40.00	3.35	48.50	3.45
22.0									20.00	2.30	36.50	2.80	45.50	3.10
23.0									10.00	2.20	32.50	2.70	43.00	2.90
24.0											29.00	2.60	40.00	2.80
25.0											23.50	2.40	37.00	2.60
26.0											16.00	2.00	33.50	2.30
27.0													29.50	2.10
28.0													25.00	1.80
29.0													20.00	1.60
30.0													13.00	1.50
 Min	0°	11.55	0°	7.10	0°	3.70	0°	2.70	0°	1.90	0°	1.35	0°	0.95

				
4.90 m	10.30m ÷ 32.40m	8.70 t	360°	CODE 16

	t2 = 0%		t2 = 50%		t2 = 100%		t2 = 100%		t2 = 100%		t2 = 100%		t2 = 100%	
	t3 = 0%		t3 = 0%		t3 = 0%		t3 = 25%		t3 = 50%		t3 = 75%		t3 = 100%	
	t4 = 0%		t4 = 0%		t4 = 0%		t4 = 25%		t4 = 50%		t4 = 75%		t4 = 100%	
	10.30 m		14.00 m		17.70 m		21.30 m		25.00 m		28.70 m		32.40 m	
														
	Max 80°	43.20	Max 80°	35.70	Max 80°	31.40	Max 80°	23.80	Max 80°	18.80	Max 80°	14.70	Max 80°	11.10
3.0	67.50	43.20												
3.5	64.50	38.10	72.50	35.70	77.00	31.40								
4.0	61.00	33.90	70.00	33.90	75.00	31.40								
4.5	58.00	30.30	68.00	30.30	73.00	29.30	76.50	23.80						
5.0	55.00	24.20	65.00	24.20	71.50	24.10	75.00	23.80	77.50	18.80				
6.0	47.00	16.90	60.50	16.90	67.50	16.90	72.00	17.40	75.00	17.50	77.50	14.70		
7.0	36.50	12.70	55.50	12.70	64.00	12.70	68.50	13.20	72.00	13.65	75.50	13.55	78.00	11.10
8.0	23.00	9.90	50.00	9.90	60.00	9.90	65.50	10.50	69.50	10.90	73.00	11.10	76.00	10.60
9.0			44.00	7.80	56.00	7.80	62.50	8.20	67.00	8.65	71.00	8.80	74.00	9.15
10.0			37.00	6.20	52.00	6.20	59.50	6.60	64.50	7.10	69.00	6.00	72.00	7.60
11.0			27.00	5.00	47.50	5.00	56.00	5.40	61.50	5.85	67.00	5.10	70.00	6.45
12.0			13.00	4.10	42.50	4.10	52.50	4.50	59.00	4.90	64.50	4.30	68.00	5.55
13.0					37.00	3.40	49.00	3.80	56.00	4.10	62.00	3.80	66.00	4.60
14.0					30.00	2.65	45.00	3.10	53.00	3.50	59.50	3.60	64.00	3.90
15.0					22.00	2.15	41.00	2.55	50.00	2.85	57.00	3.10	62.00	3.35
16.0							36.00	2.15	47.00	2.50	54.50	2.55	60.00	2.85
17.0							31.00	1.75	43.50	2.00	51.50	2.15	57.50	2.40
18.0							25.00	1.30	40.00	1.60	49.00	1.75	55.00	2.00
19.0							15.00	1.00	36.00	1.30	46.00	1.40	53.00	1.75
20.0									31.50	1.00	43.00	1.10	50.50	1.40
21.0											40.00	0.90	48.50	1.20
22.0													45.50	1.00
23.0														
24.0														
 ° Min	0°	6.20	0°	3.10	0°	1.20	0° STOP		30° STOP		38° STOP		44° STOP	

					
23.5R25 / 26.5R25	0 Km/h	10.30m ÷ 25.00m	8.70 t	0°	CODE 02

	t2 = 0%		t2 = 50%		t2 = 100%		t2 = 100%		t2 = 100%		
	t3 = 0%		t3 = 0%		t3 = 0%		t3 = 25%		t3 = 50%		
	t4 = 0%		t4 = 0%		t4 = 0%		t4 = 25%		t4 = 50%		
	10.30 m		14.00 m		17.70 m		21.30 m		25.00 m		
											
	Max 69.0°	22.10	Max 66.0°	12.40	Max 66.0°	8.90	Max 66.0°	6.95	Max 66.0°	5.70	
3.0	67.50	22.10									3.0
3.5	64.50	19.40									3.5
4.0	61.00	17.15									4.0
4.5	58.00	15.25									4.5
5.0	55.00	13.70	65.00	12.40							5.0
6.0	47.00	11.70	60.50	10.95							6.0
7.0	36.50	10.15	55.50	9.05	64.00	8.90					7.0
8.0	23.00	8.45	50.00	8.35	60.00	8.05					8.0
9.0			44.00	6.70	56.00	6.40	62.50	6.95			9.0
10.0			37.00	5.50	52.00	5.15	59.50	5.70	64.50	5.70	10.0
11.0			27.00	4.45	47.50	4.15	56.00	4.65	61.50	4.65	11.0
12.0			13.00	3.55	42.50	3.35	52.50	3.80	59.00	3.80	12.0
13.0					37.00	2.65	49.00	3.10	56.00	3.15	13.0
14.0					30.00	2.10	45.00	2.45	53.00	2.45	14.0
15.0					22.00	1.55	41.00	1.95	50.00	2.00	15.0
16.0							36.00	1.60	47.00	1.60	16.0
17.0							31.00	1.25	43.50	1.30	17.0
18.0							25.00	1.00	40.00	1.05	18.0
19.0											19.0
 min	0°	7.00	0°	3.00	0°	0.95	23° STOP		38° STOP		 min
L max α = 0°	20.00 m		20.00 m		20.00 m		20.00 m		20.00 m		L max α = 0°



MATTHEY-PETIT SA

Grues mobiles - Camions+grues - Transports - Manutentions

Succursales: 1219 Aïre-GE, Ch. de la Verseuse 7-9 ☎ 022 796 49 69
1615 Bossonens, Case Postale 82 ☎ 021 947 45 45

